

Vacuum system Euskan VSB 2000



Model:	VSB 2000
Fish Transfer Capacity:	Life fish up to 8 kg
Tank capacity:	2000 L (stainless steel)
Max. Suction height:	7 m
Max. Pressure height:	10 m
Compressor:	Samson, 37 kW – 50 Hz
Power Supply:	3 x 400 V 50 Hz
Water Supply:	20 l/min, 2 bar
Capacity:	210 m ³ /hour

Commentary:

The control system is equipped with a PLC control Box with full size PLC, touch screen with full users menu for changing program, settings and language.

Flow-watch for supply water automatic shut down by cooling water supply failure/

Stand by valve for temporary stop of system.

Standard set includes: separate 12" (300 mm) valve arrangement, suction nose for hose connection and 4 pc. 12" (300 mm) hose clips.

There is a closed hydraulic power pack for operating all valves.

The system is approved.

Advanced options:

- Wireless remote control with the following functions: Start, Stop, Standby. The system includes hand unit, receiver and antenna (receiver and antenna mounted inside the control box of the vacuum system).
- Easy changing of inlet flapper valve.
- Quick couplings on in- and outlet.
- Double operation kit (for parallel operation of 2 vacuum systems).
- Long distance pumping.
- Upgrading from 300 to 350 mm (12" - 14") is possible, but depending on the suction and discharge conditions.

www.nordicmarine.net

Main Vacuum Systems dimensions for breeding

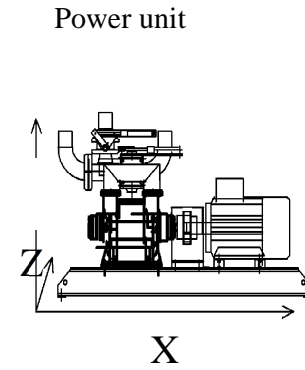
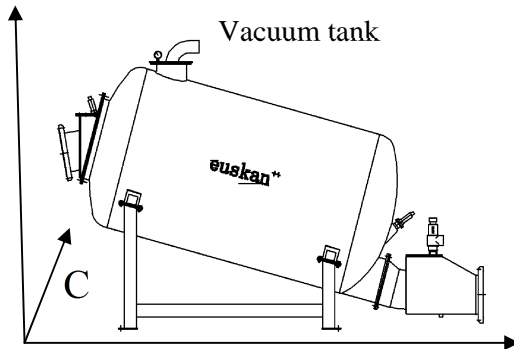

Vacuum tank dimensions

Volume	250 L	500 L	1000 L	1500 L	2000 L	3000 L	4500 L
- (mm)	1250	1650	1850	2350	2250	3000	3500
- (mm)	1050	1300	1750	1900	2100	2300	2500
- (mm)	600	750	1050	1050	1300	1300	1500
In/Out (mm)	150	200	250	250 (300)	300	300 (350)	350

Power	7,5 kW	11 kW	15 kW	30 kW	37 kW	55 kW
X- (mm)	1250	1250	1250	1900	1900	1900
Y- (mm)	900	900	900	1150	1150	1150
Z- (mm)	400	400	400	600	600	600

Power unit dimensions

www.nordicmarine.net